

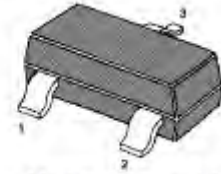

MMBD1203 SWITCHING DIODES

FEATURES

- Fast Switching Speed
- For General Purpose Switching Applications
- High Conductance

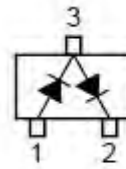

Marking Code: A7
SOT-23 Plastic Package

Absolute Maximum Ratings ($T_a = 25\text{ }^\circ\text{C}$)

Parameter	Symbol	Value	Unit
Repetitive Peak Reverse Voltage	V_{RRM}	85	V
Continuous Reverse Voltage	V_R	75	V
Continuous Forward Current (Double Diode Loaded)	I_F	125	mA
Continuous Forward Current (Single Diode Loaded)	I_F	215	mA
Repetitive Peak Forward Current	I_{FRM}	450	mA
Non-repetitive Peak Forward Surge Current	I_{FSM}	at $t = 1\text{ s}$ 0.5	A
		at $t = 1\text{ ms}$ 1	
		at $t = 1\text{ }\mu\text{s}$ 4.5	
Power Dissipation	P_{tot}	350	mW
Junction Temperature	T_j	150	$^\circ\text{C}$
Storage Temperature Range	T_{stg}	- 65 to + 150	$^\circ\text{C}$

Characteristics at $T_a = 25\text{ }^\circ\text{C}$

Parameter	Symbol	Max.	Unit			
Forward Voltage at $I_F = 1\text{ mA}$ at $I_F = 10\text{ mA}$ at $I_F = 50\text{ mA}$ at $I_F = 150\text{ mA}$	V_F	0.715 0.855 1 1.25	V			
Reverse Current at $V_R = 25\text{ V}$ at $V_R = 75\text{ V}$ at $V_R = 25\text{ V}, T_j = 150\text{ }^\circ\text{C}$ at $V_R = 75\text{ V}, T_j = 150\text{ }^\circ\text{C}$		I_R		30 1 30 50	nA μA μA μA	
Diode Capacitance at $V_R = 0, f = 1\text{ MHz}$				C_d	1.5	pF
Reverse Recovery Time at $I_F = I_R = 10\text{ mA}, I_R = 1\text{ mA}, R_L = 100\text{ }\Omega$				t_{rr}	4	ns



Typical Characteristics

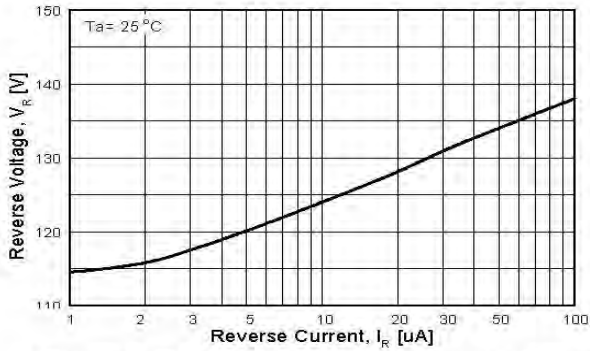

Figure 1. Reverse Voltage vs Reverse Current
BV - 1.0 to 100uA

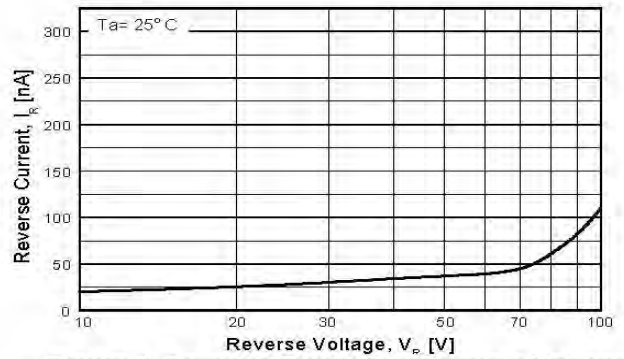

Figure 2. Reverse Current vs Reverse Voltage
IR - 10 to 100 V

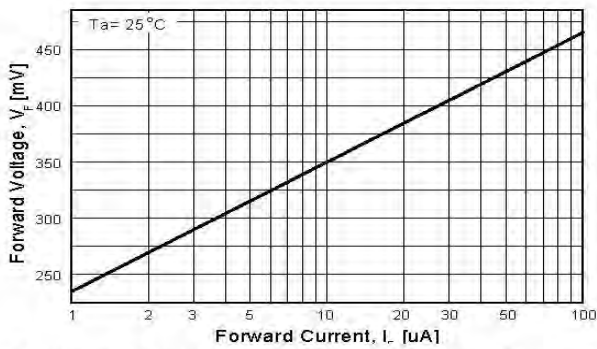

Figure 3. Forward Voltage vs Forward Current
VF - 1.0 to 100 uA

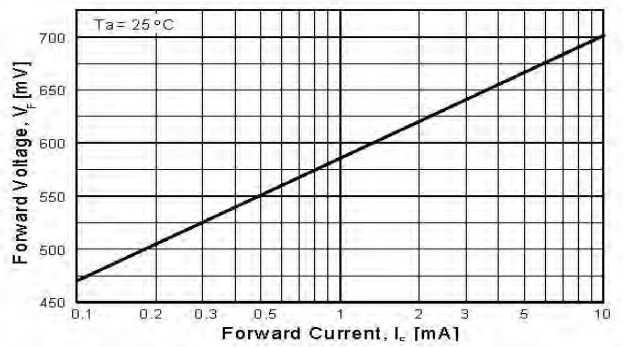

Figure 4. Forward Voltage vs Forward Current
VF - 0.1 to 10 mA

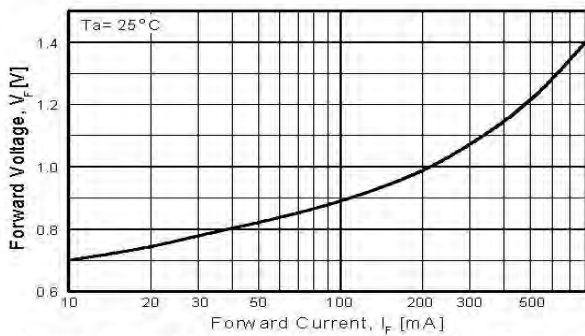

Figure 5. Forward Voltage vs Forward Current
VF - 10 - 800 mA

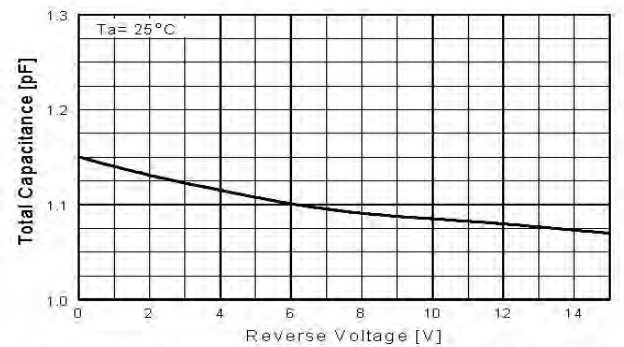

Figure 6. Total Capacitance vs Reverse Voltage

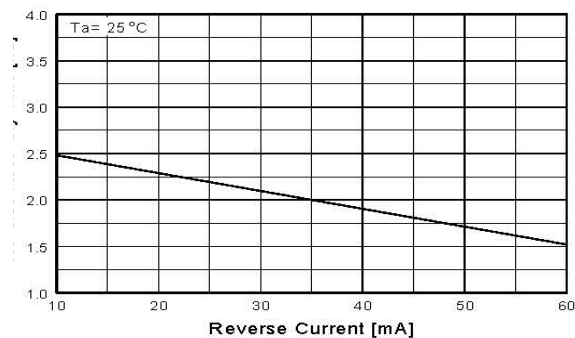

Figure 7. Reverse Recovery Time
vs Reverse Current
TRR - IR 10 mA vs 60 mA

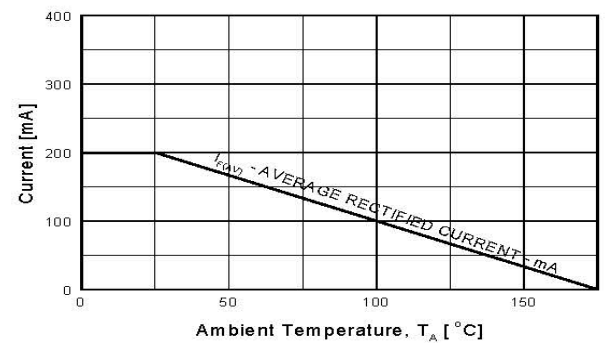

Figure 8. Average Rectified Current ($I_{F(AV)}$)
versus Ambient Temperature (T_A)



PACKAGE OUTLINE

Plastic surface mounted package; 3 leads

SOT-23

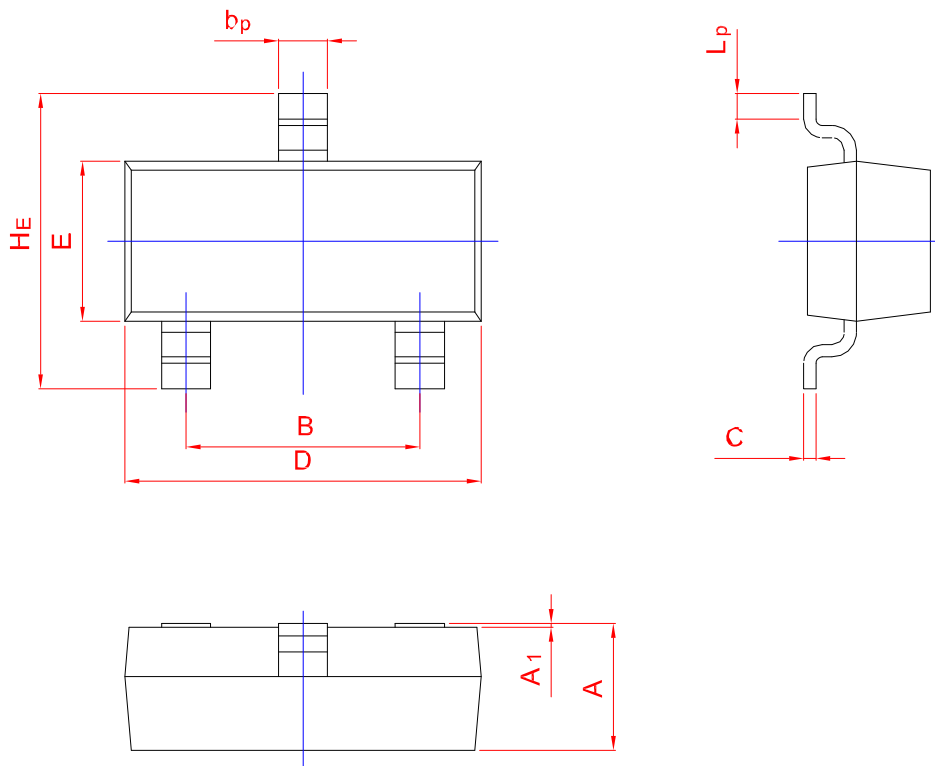
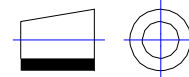

UNIT	A	B	bp	C	D	E	HE	A1	Lp
mm	1.40	2.04	0.50	0.19	3.10	1.65	3.00	0.100	0.50
	0.95	1.78	0.35	0.08	2.70	1.20	2.20	0.013	0.20